

# Application Note – Installing Environmental Sensors

## Contents

<b>Application Note – Installing Environmental Sensors</b> .....	<b>1</b>
Background .....	3
Sensor Support .....	3
Sensor Connections.....	4
Ambient Temperature Sensor (SE1000-SEN-AMB-S2).....	5
Module Temperature Sensor (SE1000-SEN-TMOD-S2).....	6
Solar Irradiance Sensor (SE1000-SEN-IRR-S1).....	7
Wind Velocity Sensor (SE1000-SEN-WIND-S1).....	8
Extending Sensor Cables .....	11
Sensor Maintenance.....	11
Using Sensor Information .....	12
Performance Ratio Calculation.....	12

## Version History

### ■ Version 2.1, March 2020

- Updated content to clarify installation steps of sensors
  - Connection images
  - Connection steps

### ■ Version 2.0, January 2019

- Updated content to reflect new temperature and irradiance sensors
  - Product numbers
  - Product images
  - Wiring instructions and diagrams
  - Added reference to the Surge Protection Application
- Added
  - instructions for mounting module temperature sensor
  - Cable extension instructions
  - Maintenance instructions

### ■ Version 1.1, Oct 2018 –

Changed Control and Communication Gateway to Commercial Gateway

### ■ Version 1.0, Nov 2016 – Initial version

This document is intended to assist in planning environmental sensor installations in commercial projects and should be used in conjunction with the following documents:

#### ■ SolarEdge Commercial Gateway Installation Guide

<http://www.solaredge.com/files/pdfs/solaredge-gateway-installation-guide.pdf>

#### ■ SolarEdge Commercial Gateway Datasheet

[http://www.solaredge.com/files/pdfs/products/inverters/se\\_control\\_and\\_communication\\_gateway.pdf](http://www.solaredge.com/files/pdfs/products/inverters/se_control_and_communication_gateway.pdf)

#### ■ SolarEdge Environmental Sensors Datasheet

[http://www.solaredge.com/files/pdfs/products/inverters/se\\_sensor\\_datasheet.pdf](http://www.solaredge.com/files/pdfs/products/inverters/se_sensor_datasheet.pdf)

- SolarEdge Application Note – Monitoring Platform Performance Ratio Calculation

[http://www.solaredge.com/files/pdfs/monitoring\\_performance\\_ratio\\_calculation.pdf](http://www.solaredge.com/files/pdfs/monitoring_performance_ratio_calculation.pdf)

- SolarEdge Application Note - Overvoltage Surge Protection - Technical Note, Europe and APAC

[https://www.solaredge.com/sites/default/files/lightning\\_surge\\_protection.pdf](https://www.solaredge.com/sites/default/files/lightning_surge_protection.pdf)

Overvoltage Surge Protection - Technical Note, North America

[https://www.solaredge.com/sites/default/files/overvoltage\\_surge\\_protection\\_na.pdf](https://www.solaredge.com/sites/default/files/overvoltage_surge_protection_na.pdf)

For complete instructions in planning environmental sensor installations in commercial projects go to: <https://www.imt-solar.com>

## Background

Environmental sensors are used to monitor a site's irradiance, temperature and wind conditions and calculate performance ratio (PR). Sensors connect to the SolarEdge Commercial Gateway and the measurements are displayed in the SolarEdge monitoring server.

Up to three sensors can be connected to a single Commercial Gateway.



### NOTE

When connecting more sensors than supported by a single gateway, use an additional Commercial Gateway.

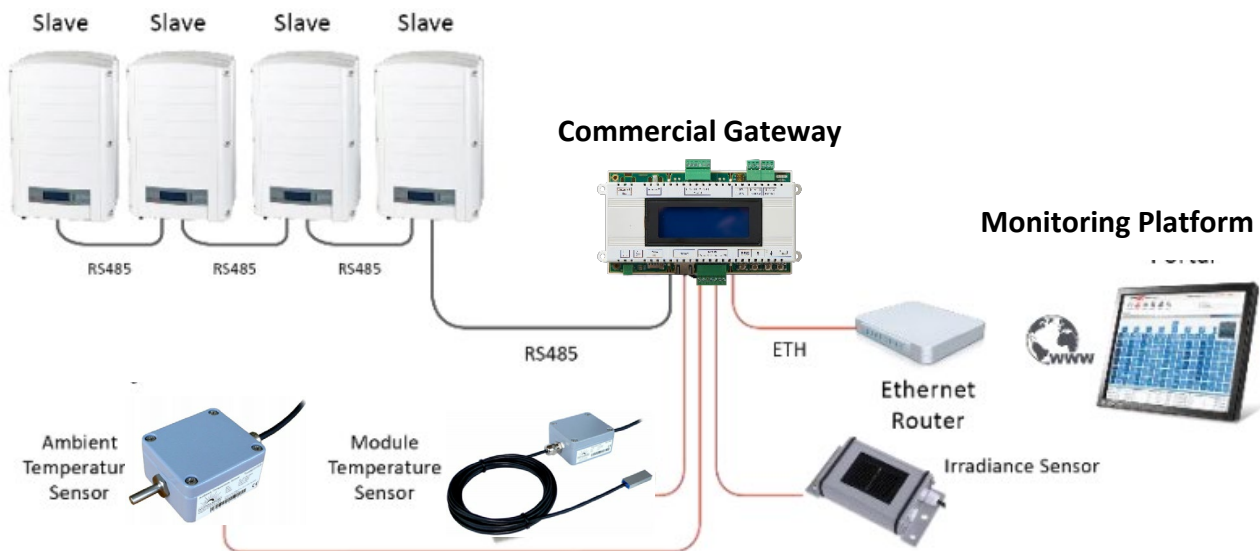

Figure 1: Commercial Gateway Connected to 3 Sensors

## Sensor Support







The Commercial Gateway supports any environmental sensor meeting the specifications found in the Commercial Gateway datasheet. SolarEdge offers irradiance, ambient temperature, module temperature and wind velocity sensors.

Additional SolarEdge approved sensors are available from Ingenieurbüro Mencke & Tegtmeyer GmbH. Please refer to <http://www.solaredge.com/se-supported-devices> for further details and specifications of approved environmental sensors.

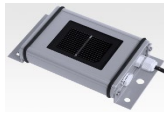
To allow flexible connection of sensors, 3 analog inputs are available with different configurable input ranges:

- V1: 0-2V or 0-30mV, user configurable
- V2: 0-10V or 0-2V, user configurable
- I: 0-20mA

The table below includes a list of approved sensors and the input connectors to which they can be connected. Part numbers of sensors available from SolarEdge begin with the prefix "SE1000".

						
Sensor Input	SI Irradiance	Module Temperature	Ambient Temperature	Pyranometer	Wind Velocity	Wind Direction
V1 (0-2V)	<b>SE1000-SEN-IRR-S1</b> / Si-V-1.5TC (**)			SMP11-V (*)	4.3519.00.167	4.3129.00.167
V2 (0-10V)	Si-V-10TC	Tm-V-4090	<b>SE1000-SEN-TAMB-S2</b> / Ta-V-4090			
I (0-20mA)	Si-I-420TC	<b>SE1000-SEN-TMOD-S2</b> / Tm-I-4090	Tamb420 Ta-I-4090	SMP11-A	<b>SE1000-SEN-WIND-S1</b> / 4.3519.00.141	4.3129.00.141

Notes:

(\*) 0-1 VDC

(\*\*) 0-1.5 VDC

Follow the instructions in the section, "Configuring Environmental Sensors" in the *SolarEdge Commercial Gateway Installation Guide*, <http://www.solaredge.com/files/pdfs/solaredge-gateway-installation-guide.pdf>, to configure the sensors.

## Sensor Connections

The following table details the Commercial Gateway's 7 pin sensor terminal block inputs/outputs and their designation:

Pin #	Pin Name	Description
1	V1	Voltage sensor input number 1
2	GND	Ground - common for V1 & V2
3	V2	Voltage sensor input number 2
4	I-	Negative current sensor input
5	I+	Positive current sensor input
6	GND	Ground - common for V1 & V2
7	12V	12 VDC output voltage supply for sensors

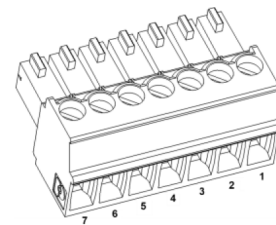
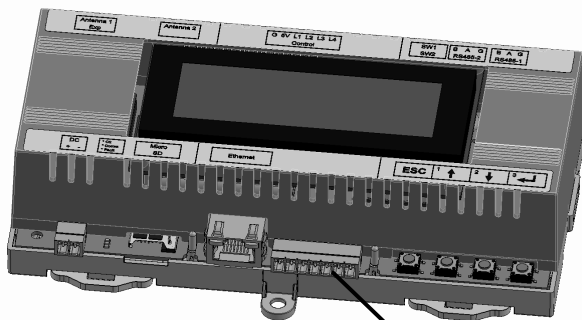

Figure 2: Sensor 7-Pin Terminal Block



Sensors connector

Figure 3: Position of Sensor Connector on the Commercial Gateway

All sensors can be powered by the Commercial Gateway. The Commercial Gateway can power up to 3 sensors simultaneously.

**NOTE**

Wiring of both ambient and temperature sensors has changed to reflect new markings on the sensor and include grounding of the cable. The instructions below refer to the currently available sensors- identifiable by the pre-wired cable on the sensor output.

## Ambient Temperature Sensor (SE1000-SEN-AMB-S2)

→ **To connect the Ambient Temperature Sensor to the Commercial Gateway:**

Connect the sensor to the Commercial Gateway as shown in Figure 4 below:

1. Red wire to **12V**
2. Black wire to **GND**
3. Brown wire to **V2**
4. Cable shield to **GND**

Sensors Terminal Connector

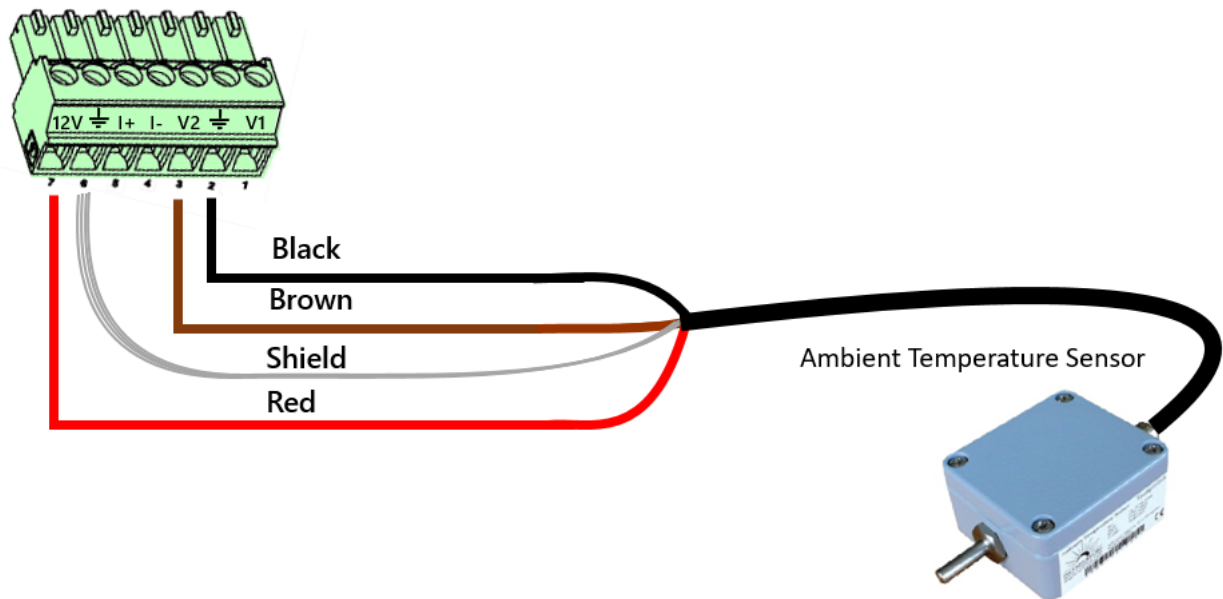

Figure 4: Connecting the Ambient Temperature Sensor

→ To mount the Ambient Temperature Sensor:

1. Install under a cover to protect the sensor from direct exposure to sunlight, precipitation and meltwater.
2. Mount the sensor in correct orientation

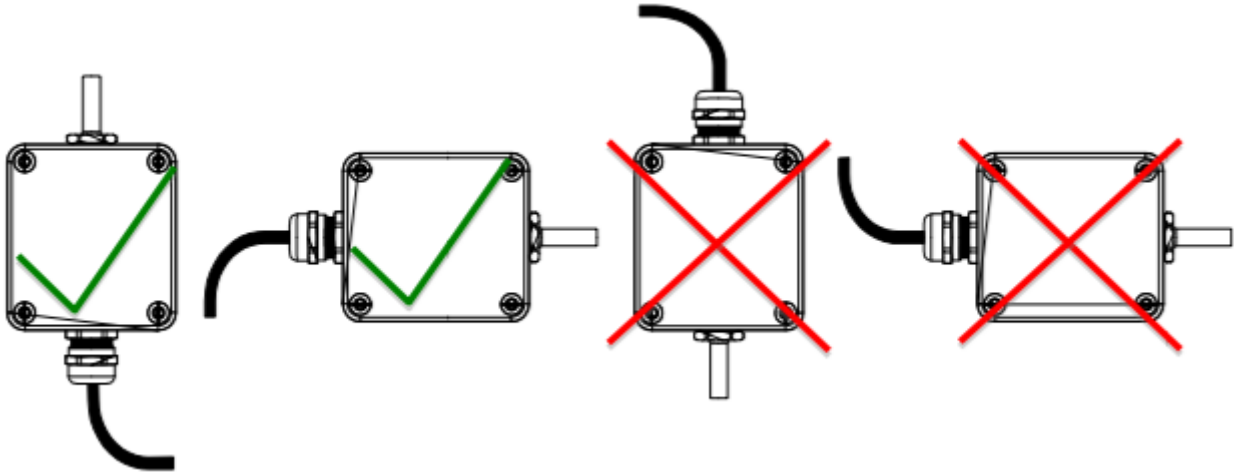

Figure 5: Correct mounting orientation of the Ambient Temperature Sensor

Module Temperature Sensor (SE1000-SEN-TMOD-S2)

→ To connect the Module Temperature Sensor to the Commercial Gateway:

Connect the sensor to the Commercial Gateway as shown in Figure 6 below:

1. Red wire to the **12V**
2. Black wire to the **GND**
3. Brown wire to the **I+**
4. Bridge the **I-** (see the blue line)
5. Cable shield to the **GND**

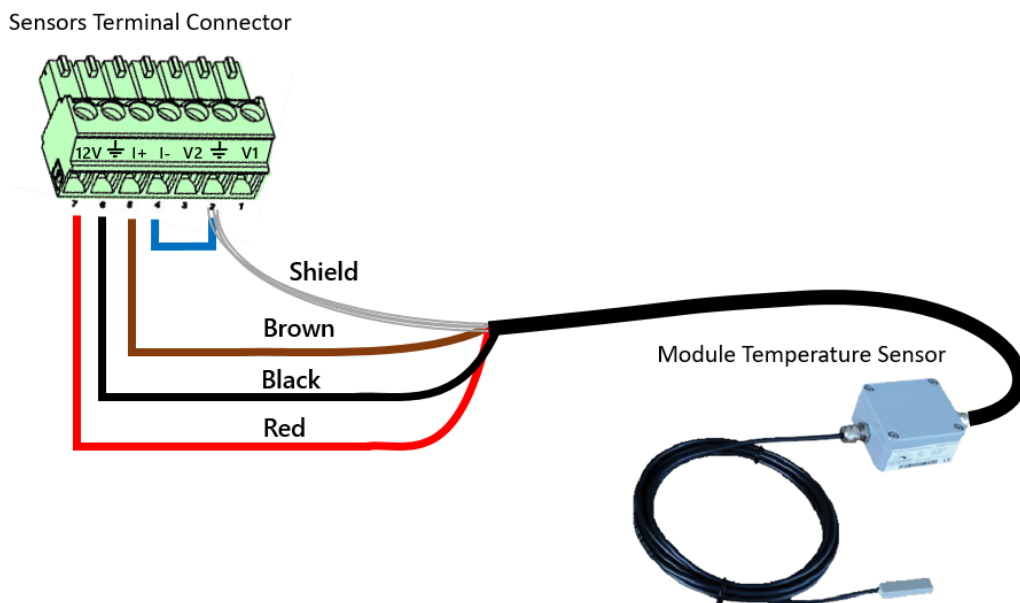

Figure 6: Connecting the Module Temperature Sensor

To connect the Module Temperature Sensor element to the module:

1. Glue the sensor element (aluminum block) directly to the module back sheet.
2. The surface must be dry, clean and degreased before affixing the element to the surface.
3. In applications where module temperature is expected to reach >75°C it is recommended to use additional adhesive.
4. Measurement accuracy may be increased by completely covering the sensor element in silicone or adhesive.

→ **To mount the Module Temperature Sensor:**

1. Install under a cover to protect the sensor housing and block from direct exposure to sunlight, precipitation and meltwater.
2. Mount the sensor in correct orientation

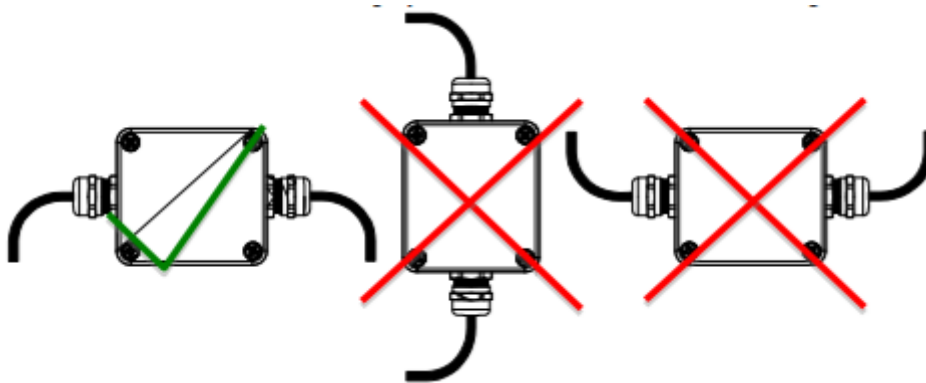

Figure 7: Correct mounting orientation of the Module Temperature Sensor

### Solar Irradiance Sensor (SE1000-SEN-IRR-S1)

→ **To connect the Solar Irradiance Sensor to the Commercial Gateway:**

Connect the colored sensor wires to Commercial Gateway as shown in Figure 8 below:

1. Red wire to **12V**
2. Black wire to **GND**
3. Cable shield to **GND**
4. Orange wire to the **V1**

Sensors Terminal Connector

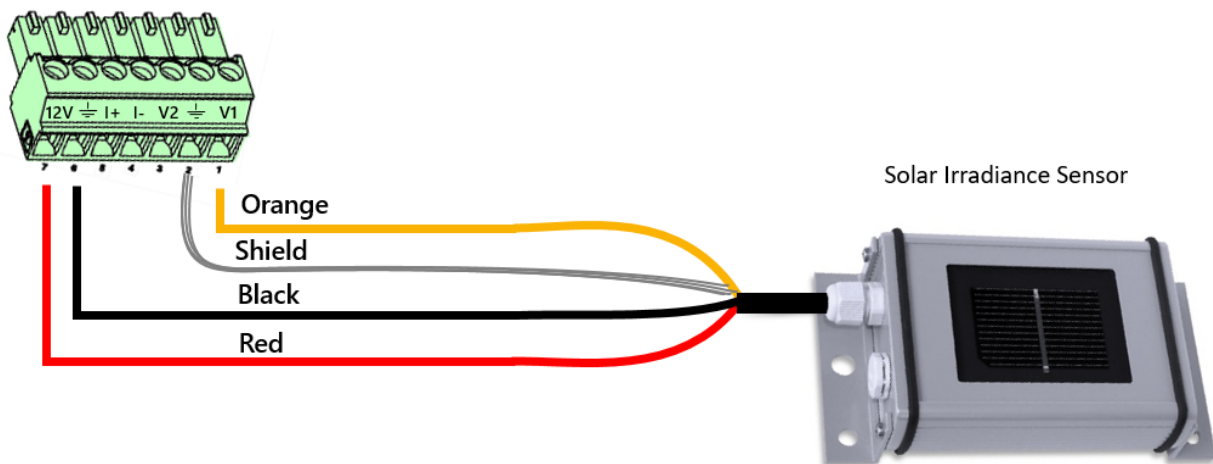

Figure 8: Connecting the Solar Irradiance Sensor

→ **To mount the Solar Irradiance Sensor:**

1. Sensor angle and tilt shall match exactly to the array it is referencing.
2. Ensure there is no additional shading on the sensor (e.g. from the module frame).
3. Ensure the mounting location is accessible for periodic inspection and cleaning.
4. Avoid installation along meltwater paths.
5. Lay cable separately from AC and DC lines.
6. Cable bending radius shall be  $>5\text{mm}$
7. Mount the sensor in correct orientation

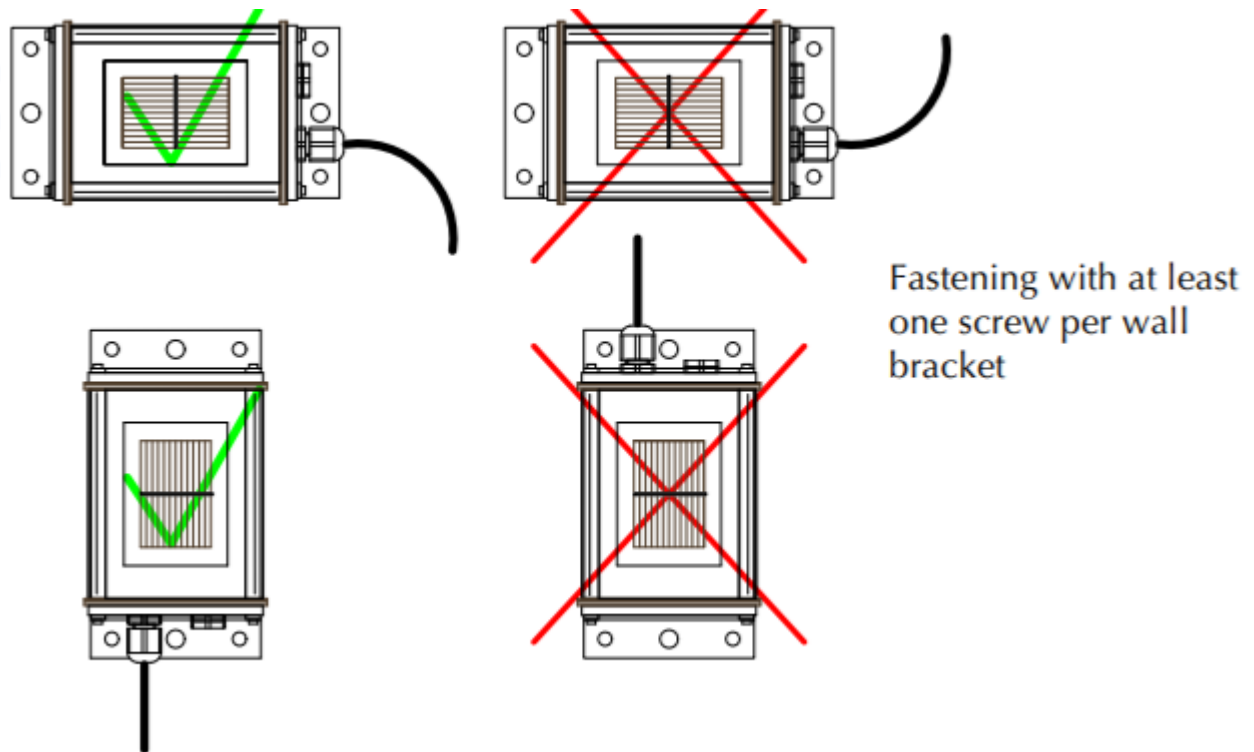

Figure 9: Correct mounting orientation of the Solar Irradiance Sensor



**NOTE**

When configuring this sensor in the Commercial Gateway, the type should be "Irradiance Direct".  
The surge protection concept must be adapted to the specific installation. The surge protection concept must be adapted to the specific installation. The surge protection concept must be adapted to the specific installation.

## Wind Velocity Sensor (SE1000-SEN-WIND-S1)

→ **To connect the Wind Velocity Sensor to the Commercial Gateway:**

Connect the wind velocity sensor to the Commercial Gateway using a LiYCY 6 x 0.25mm<sup>2</sup> cable.

The sensor is supplied with a heating system that prevents the ball bearing and external rotation parts from freezing. When operated, the heating system consumes 20W and requires an external 24V power supply.



→ To connect the sensor without enabling use of the heating system:

Connect the sensor to the Commercial Gateway as specified in the following table:

**Table 1: Wind Velocity Sensor Connectivity**

Commercial Gateway Pin	Sensor Wire	Commercial Gateway to Commercial Gateway Connections	Sensor Wire Connections
2		Short Commercial Gateway pins 2 and 4	
4		Short Commercial Gateway pins 2 and 4	
5: I+	3 (green)		
6: GND	2 (brown)		
7: 12V	1 (white)		

→ To connect the sensor – enabling use of the heating system:

When deploying the heating system, connect the powering wires of both the sensor **and** the heating system to the external 24V power supply.

Connect the sensor and heating system to the Commercial Gateway and external 24V power supply as specified in the following table:

**Table 2: Wind Velocity Sensor and Heating System Connectivity**

Commercial Gateway Pin	External PS Terminal	Sensor Wire	Commercial Gateway to Commercial Gateway Connections	Sensor Wire Connections
2			Short Commercial Gateway pins 2 and 4	
4			Short Commercial Gateway pins 2 and 4	
5: I+		3 (green)		
	+	2 (brown), 6 (pink)		
	-	1 (white), 5 (gray)		

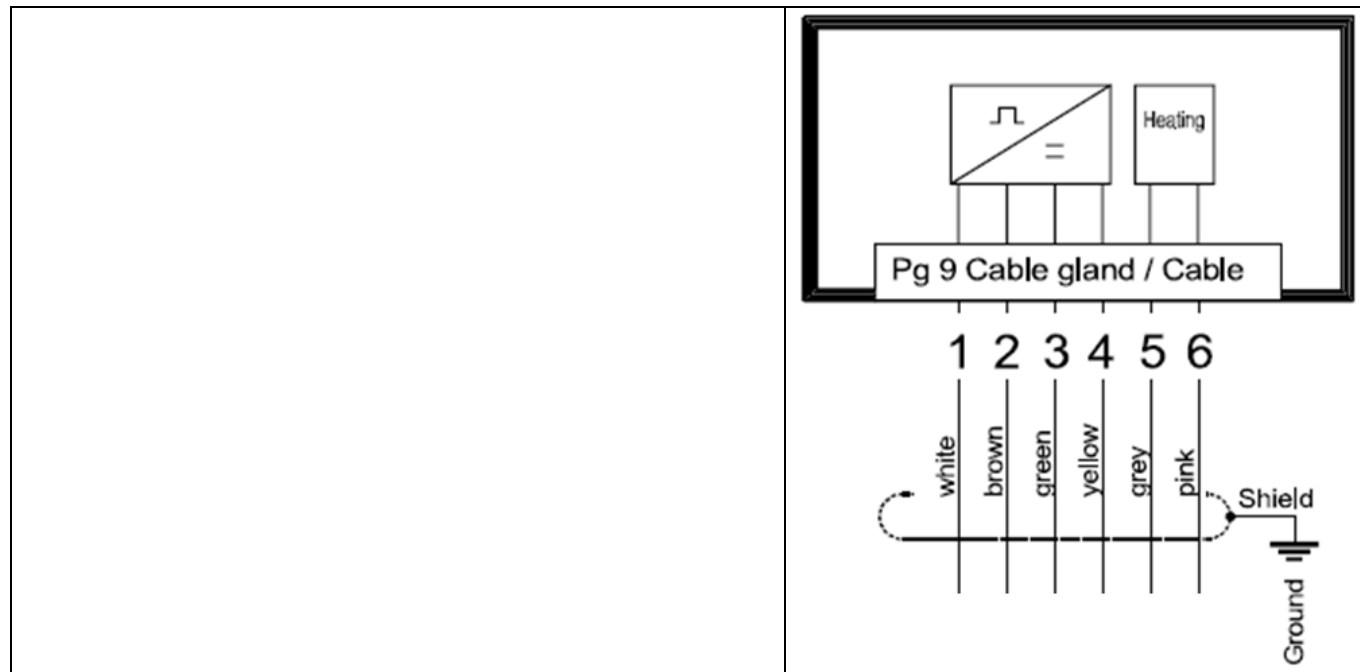

## Extending Sensor Cables

It is possible to extend the original shielded cables if needed, up to the following length (meter) of additional shielded cabling:

Sensor		Cable Diameter						
		0.14 mm <sup>2</sup>	0.25 mm <sup>2</sup>	0.34 mm <sup>2</sup>	0.5 mm <sup>2</sup>	0.75 mm <sup>2</sup>	1.0 mm <sup>2</sup>	1.5 mm <sup>2</sup>
Temperature	SE1000-SEN-TAMB-S2, Ta-V-4090, Tm-V-4090	30	50	70	100	100	100	100
	SE1000-SEN-TMOD-S2, Tm-I-4090, Ta-I-4090	200	200	200	200	200	200	200
Irradiance	Si-V-1.5TC	50	50	50	50	50	50	50
	Si-V-10TC	100	100	100	100	100	100	100
	Si-I-420TC	200	200	200	200	200	200	200

## Sensor Maintenance

### → Temperature Sensors

- The sensors should be checked once a year for damage, contamination and correct fitting.

### → Irradiance Sensors

- At least once every two years (note that some locations will require higher frequency to maintain accurate results);
  - The solar cells shall be cleaned- using a soft cotton cloth, with water and a mild cleaning agent
  - Inspected for external damage
  - Confirm proper mechanical fastening
  - Damage to cabling and cable management
- A re-calibration is recommended at least every 3 years. Details can be found at the manufacturer’s website.

### → Wind Velocity Sensors

- The sensors should be checked once a year for damage, contamination and correct fitting.
- After proper mounting the sensor operates maintenance free.
- Heavy pollution can clog up the slit between the rotating and the stationary parts of the sensor.
- Clean the slit once a year using cotton cloth with mild detergent.

## Using Sensor Information

Once the Commercial Gateway and environmental sensors have been installed and configured, the sensor readings are accessible in the monitoring platform: *Charts* -> *Environmental* -> *On-site sensors*. See the example below, in which information from three sensors is displayed.

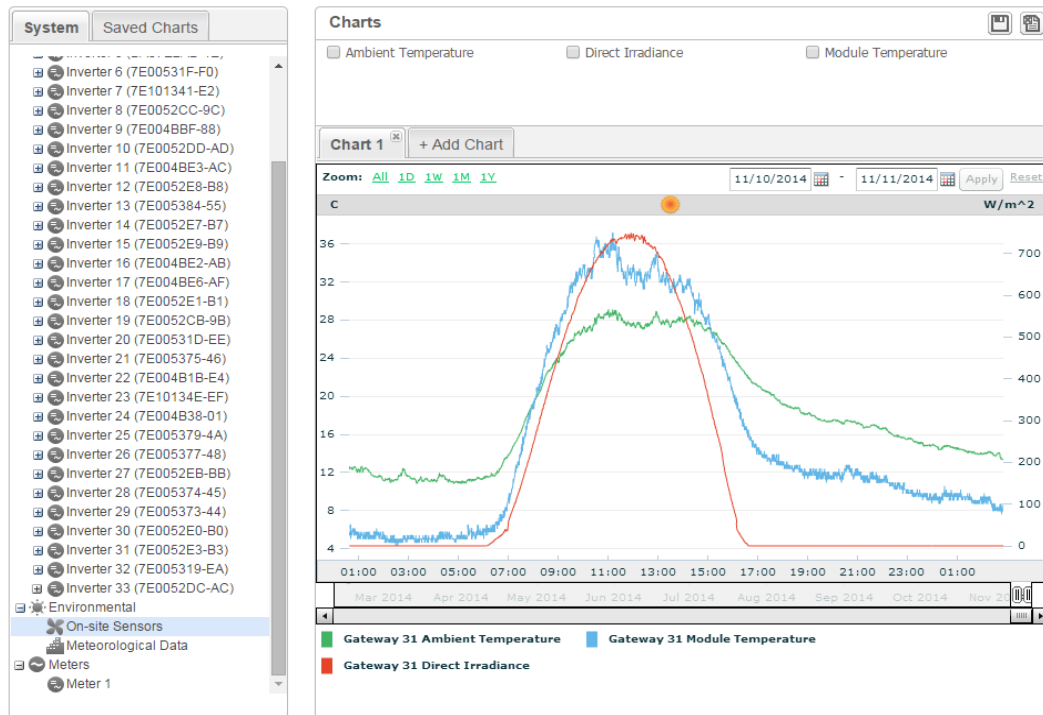

Figure 10: Viewing sensor readings on the monitoring platform

## Performance Ratio Calculation

Following installation of the sensors, you can enable performance ratio calculations in the monitoring platform. To enable the performance ratio calculations, see the application note: *Monitoring Platform Performance Ratio Calculation*.

[http://www.solaredge.com/sites/default/files/monitoring\\_performance\\_ratio\\_calculation.pdf](http://www.solaredge.com/sites/default/files/monitoring_performance_ratio_calculation.pdf)